

### Supported Features

- input energy tuning 0.2mJ - 2mJ\*
- no active cooling up 100W
- 10 fold pulse compression up to 1.3ps input pulses
- up to 100mJ input energy
- up to 250W input (air cooled)

\*compressed pulse duration can be preserved if ONLY the input energy is varied

### few-cycle HiT fiber - 90% Transmission@ 80W with CARBIDE CB3

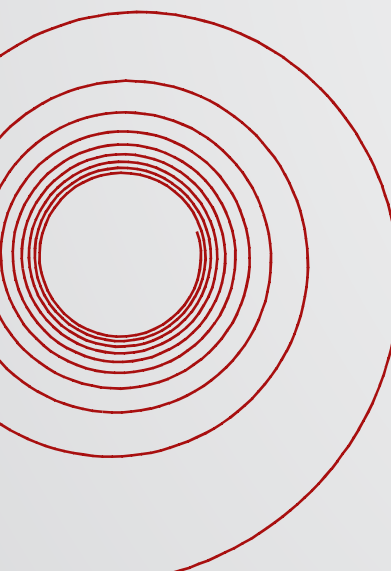
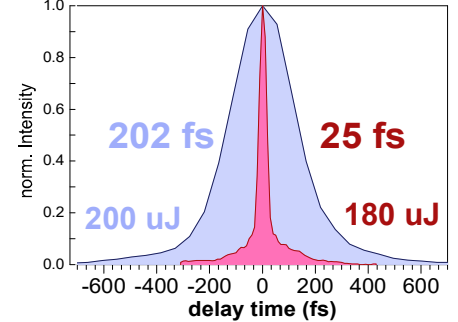
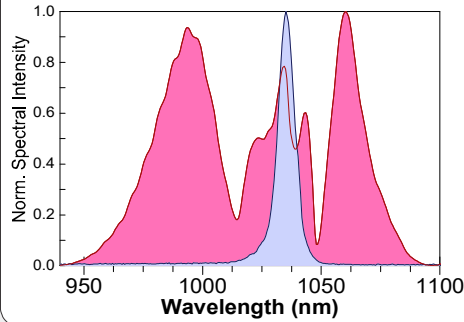

### Double Stage - 50 fold compression with 60% Transmission @ 80W, 2mJ

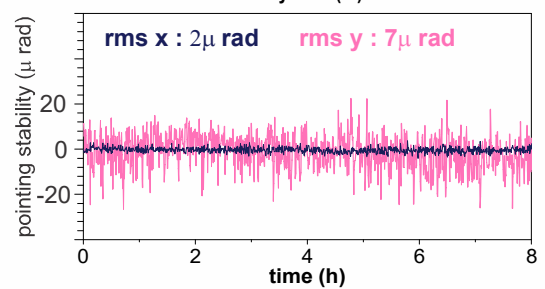
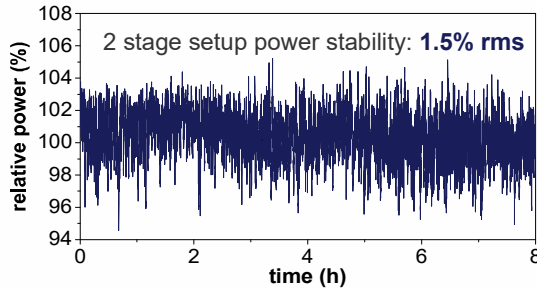
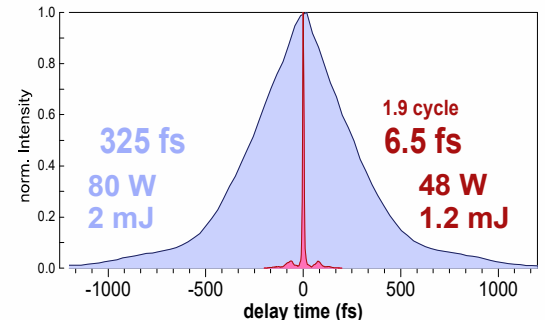
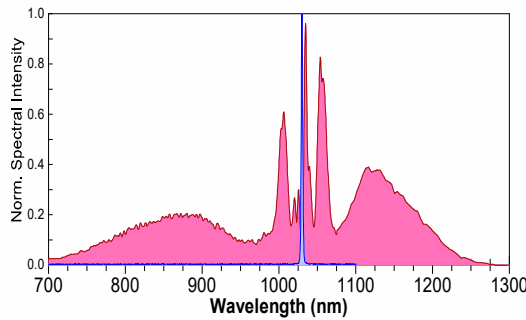

### Tiny Cube miniature vacuum beam routing system

- Options:
- telescopic vacuum tubes
  - vacuum motion control with same footprint

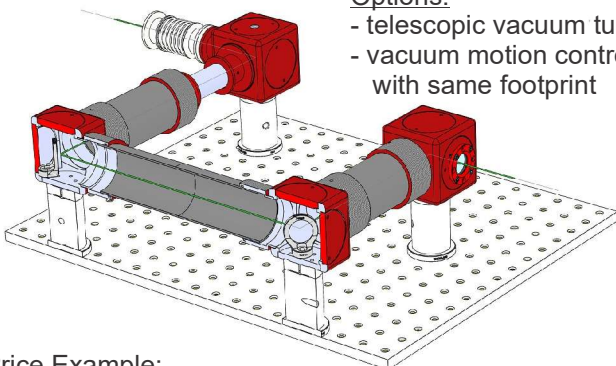

Price Example:  
pictured setup for four 1" optics starting at 3,000 USD

### fs enhanced Ag-mirrors with low thermal distortion

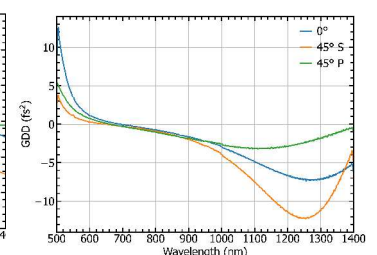
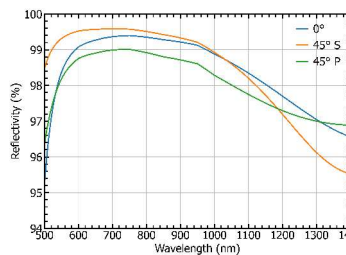

- up to 100W with passive cooling
- up to 200W with water cooled mounts
- Optimized reflectivity and GDD for 45° AOI